

# MC 48 C

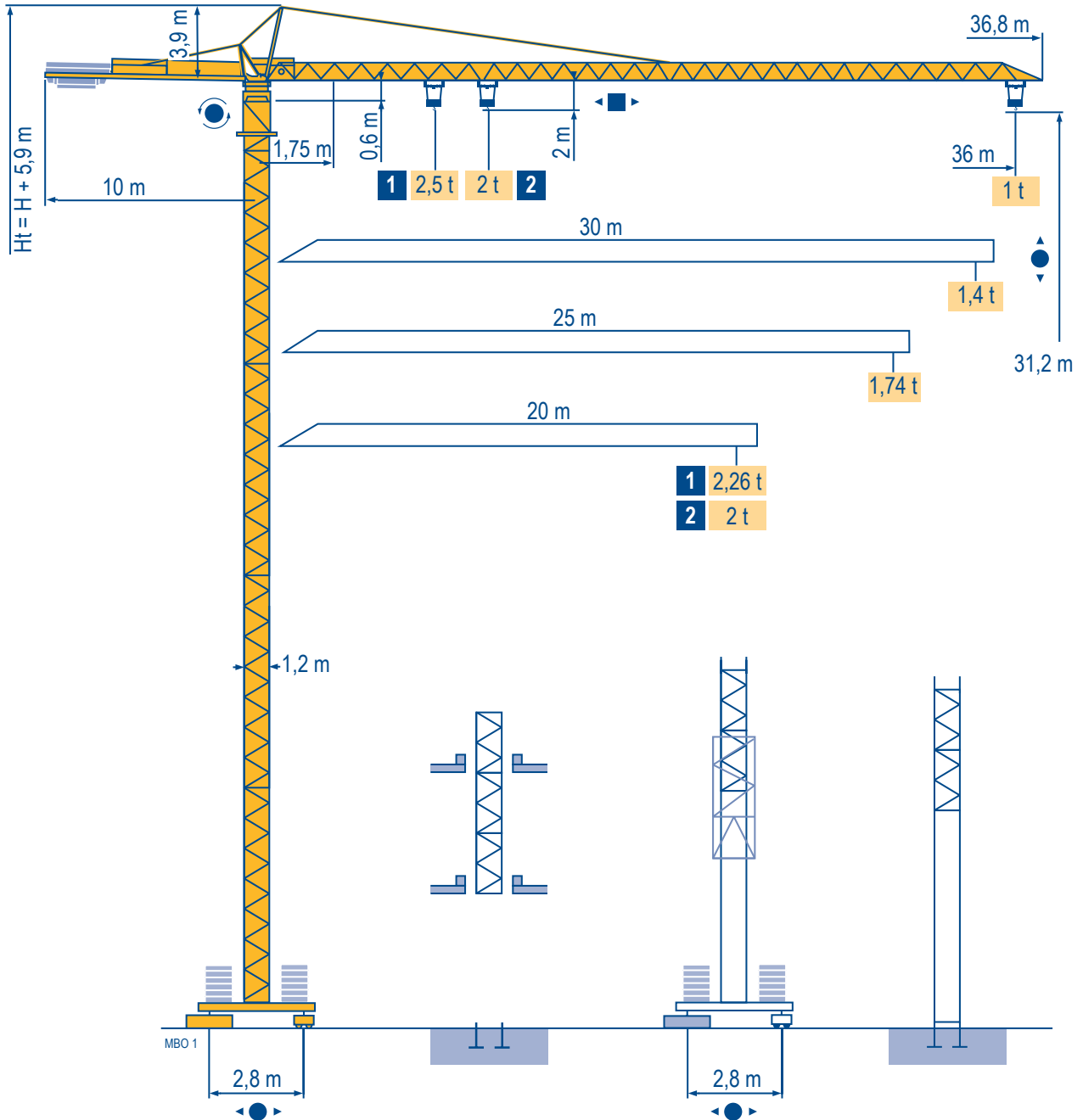

**CITY CRANE**

**CE** FEM 1.001-A3

Mat / Réactions □ 1,2 m  
 Maste / Eckdrücke ▴  
 20 m ⇒ 36 m  
 Masts / Reactions  
 Mástil / Reacciones  
 Torre / Reazioni  
 Tramo / Reações

MBO 1

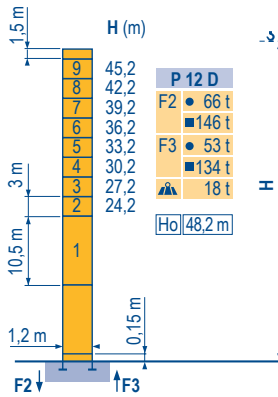
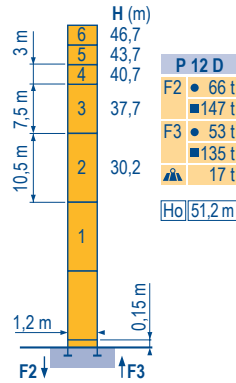
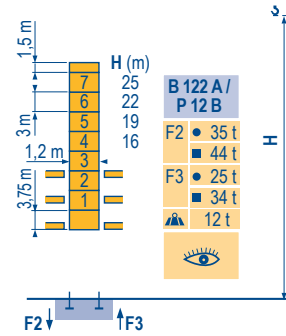
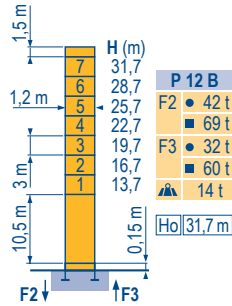
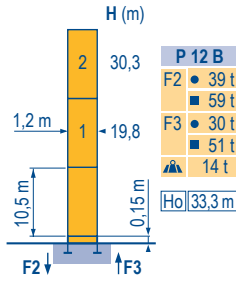

□ 1,2 m  
 ▴  
 20 m ⇒ 36 m

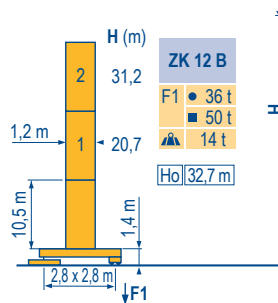
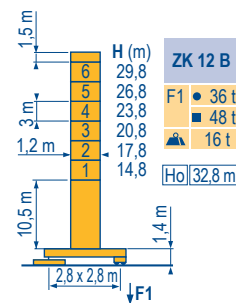

ZK

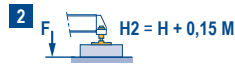

CITY CRANE  
 MC 48 C



F	D	GB	E	I	P
● Réactions en service	● Reaktionskräfte in Betrieb	● Reactions in service	● Reacciones en servicio	● Reazioni in servizio	● Reações em serviço
■ Réactions hors service	■ Reaktionskräfte außer Betrieb	■ Reactions out of service	■ Reacciones fuera de servicio	■ Reazioni fuori servizio	■ Reações fora de serviço
▲ A vide sans lest (ni train de transport) avec flèche et hauteur maximum.	▲ Ohne Last, Ballast (und Transportachse), mit Maximalausleger und Maximalhöhe.	▲ Without load, ballast (or transport axles), with maximum jib and maximum height.	▲ Sin carga, sin lastre, (ni tren de transporte), flecha y altura máxima.	▲ A vuoto, senza zavorra (ne assali di trasporto) con braccio massimo e altezza massima.	▲ Sem carga (nem trem de transporte)- sem lastro com lança e altura máximas.
Ho H sans cabine	Ho H Ohne Fahrerhaus	H without cab	H sin cabina	H senza cabina	H sem cabine

Courbes de charges  
 Lastkurven  
 Load diagrams  
 Curvas de cargas  
 Curve di carico  
 Curva de cargas

MBO 1

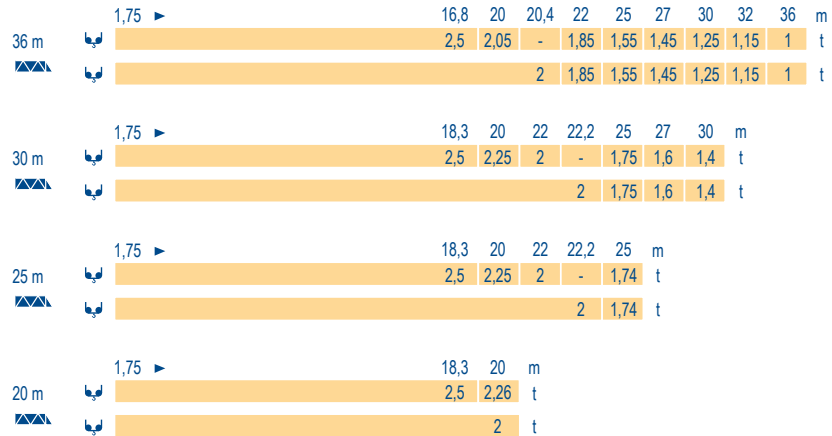

Télescopage sur dalles  
 Kletterkrane im Gebäude  
 Climbing crane  
 Telescopage gruas trepadoras  
 Gru in cavedio  
 Telescopagem sobre lages

MBO 1

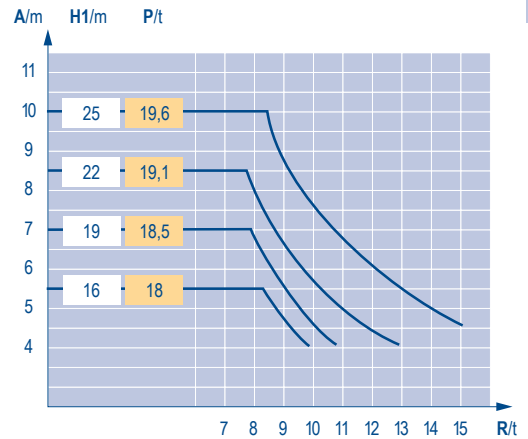
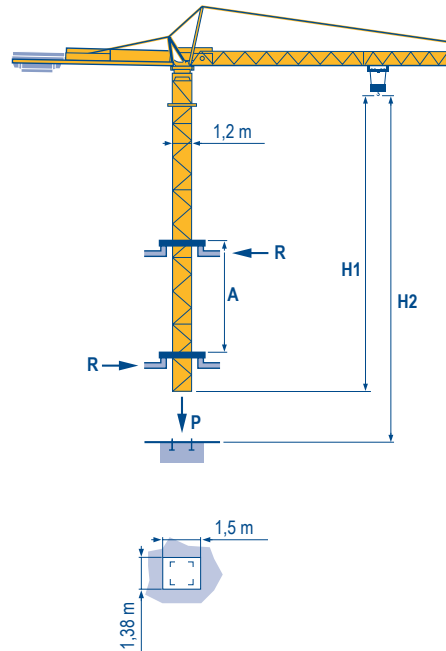

B 122 A

CITY CRANE  
 MC 48 C



	F	D	GB	E	I	P
<b>A</b>	Distance entre cadres	Abstand zwischen den Rahmen	Distance between collars	Distancia entra marcos	Distanza fra i telai	Distância entre quadros
<b>H1</b>	Hauteur grue	Kranhöhe	Crane height	Altura grúa	Altezza gru	Altura da grua
<b>P</b>	Poids de la grue(en service)	Krangewicht (in Betrieb)	Crane weight (in service)	Peso de la grúa (en servicio)	Peso della gru (in servizio)	Peso da grua (em serviço)
<b>R</b>	Réaction horizontale	Horizontalkräfte	Horizontal reaction	Reaccion horizontal	Reazione orizzontale	Reacção horizontal
	Voir télescopage sur dalles	Siehe Kletterkrane im Gebäude	See climbing crane	Vea grua trepadora	Consultare gru in cavedio	Ver telescopagem sobre lages

Mécanismes  
Antriebe  
Mechanisms  
Mecanismos  
Meccanismi  
Mecanismos

MBO 2

					ch - PS hp	kW		
	9 RPC 10-3	m/min	6,6	20	40	8,2	6	115 m
		t	2	2	1			
	15 PC 10-2	m/min	7,5	22	45	15	11	229 m
		t	2	2	1			
	15 PC 13-5	m/min	7,1	21	42	15	11	130 m
		t	2,5	2,5	1,3			
	1 D2 V1	m/min	18 - 36			1,2	0,9	
	RCV 30	tr/min U/min rpm	0 → 0,8			4	3	
	TVD 324	m/min	26			2 x 4	2 x 2,9	
		CEI 38	IEC 38		kVA			
		400 V (+6% -10%) 50 Hz			9 PC : 15 kVA 15 PC : 20 kVA			

F

Levage  
Distribution  
Orientation  
Translation

D

Heben  
Katzfahren  
Schwenken  
Kranfahren

GB

Hoisting  
Trolleying  
Slewing  
Travelling

E

Elevación  
Distribución  
Orientación  
Traslación

I

Sollevamento  
Distribuzione  
Rotazione  
Traslazione

P

Elevação  
Distribuição  
Rotação  
Translação



Document commercial non contractuel. Pour toute information technique se référer à la notice correspondante.

Unverbindliches Vertriebsdokument. Für technische Informationen, siehe die entsprechenden Anweisungen.

This commercial document is not legally binding. For any technical information, please refer to the corresponding instructions.

Documento comercial non contractuel. Para cualquier información técnica, ver la noticia correspondiente.

Documento commerciale non vincolante, per tutte le informazioni tecniche fare riferimento al catalogo istruzioni.

Documento comercial não contratual. Para qualquer informação técnica complementar consultar as respectivas instruções.

**Manitowoc**  
Crane CARE

**POTAIN**   
Manitowoc Crane Group



Americas

Tel : +1 888 479 7278  
Tel : +1 717 593 2000

Europe - Middle East - Africa

Tel : +33 (0) 4 72 81 50 00  
Tel : +44 (0) 191 522 2000

Asia - Pacific

Tel : +65 6264 1188  
Fax : +65 6862 4142

www.manitowoccrane.com

18, rue de Charbonnières - B.R.173  
69132 ECULLY Cedex - France

Tél. : +33 (0) 4 72 18 20 20  
Fax. : +33 (0) 4 72 18 20 00  
www.manitowoccrane.com

**CITY CRANE MC 48 C**

Réf. 2004 42 MBO 2

Copyright.Reproduction interdite © POTAIN 2004

Réalisation Secloc